



**lumeplus**  
[www.lume-plus.com](http://www.lume-plus.com)

**TRACK LIGHTING ACCESSORIES**



LUMEPLUS is focused on developing and manufacturing technical LED luminaires for retail and architect areas. All our Products and service are born to meet people's constant pursuit for better and more comfortable illuminated lighting environment. Such pursuit gives our team and partners the strengths to innovate and constantly strive for perfection.

Our technically sophisticated and aesthetically convincing LED luminaires are highly recommended and used by lighting/interior designers, electrical contractors, developers, architects and Property/shop owners.

Established in 2013, our experiences during the past years are all about LEDs and LED Lighting. Backed up with an experienced dynamic and innovative R&D team, we're able to Provide quick OEM and ODM solutions tailored to fit customers' specific lighting requirements for retail and architect areas.

#### OUR UNIQUE POSITION

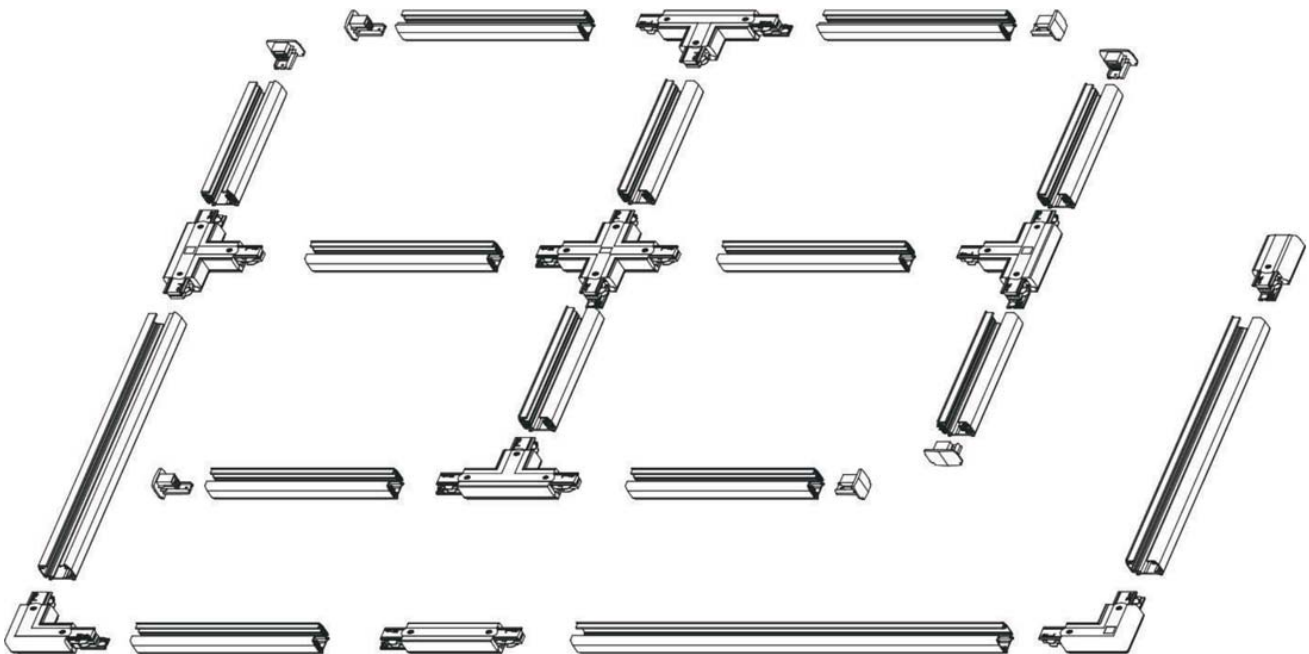

IEC:EN60570

RoHS

## 3 Phase Track Rail System

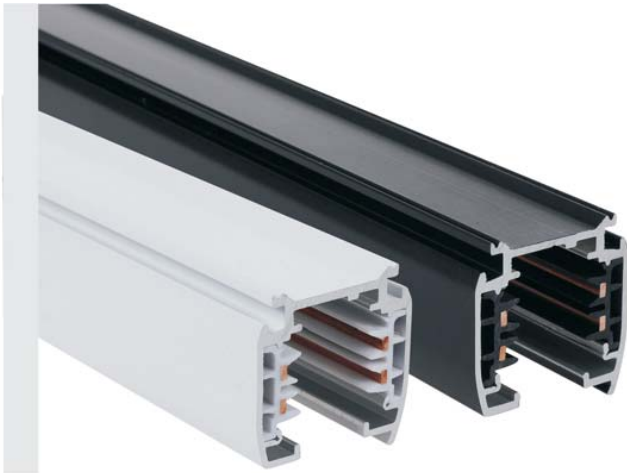

Each track adopts copper wires with plastic unibody process.

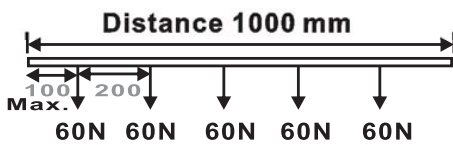

L/mm	a/mm	b/mm	c/mm	d/mm
1000	100			
2000	100	1000		
3000	100		1500	
4000	100		1333	1333

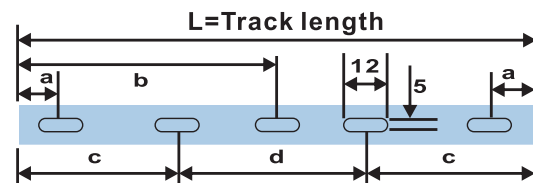
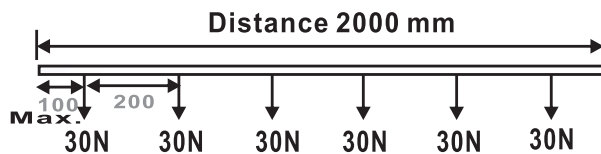

Available colours: -W(white Ral 9003), -B(black Ral 9004), -G(gray Ral 7040).

Type	Dimensions in mm/ track length	Surface Colour	PCS/ Carton
TL-04C1-1-W	1000	White	12
TL-04C1-1-B	1000	Black	12
TL-04C1-1-G	1000	Gray	12
TL-04C1-2-W	2000	White	12
TL-04C1-2-B	2000	Black	12
TL-04C1-2-G	2000	Gray	12
TL-04C1-3-W	3000	White	12
TL-04C1-3-B	3000	Black	12
TL-04C1-3-G	3000	Gray	12
TL-04C1-4-W	4000	White	12
TL-04C1-4-B	4000	Black	12
TL-04C1-4-G	4000	Gray	12

## Recessed 3 Phase Track Rail System

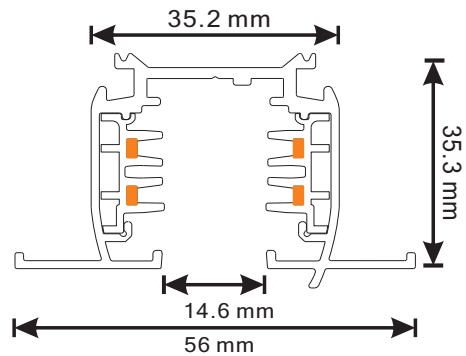

Each track adopts copper wires with plastic unibody process.

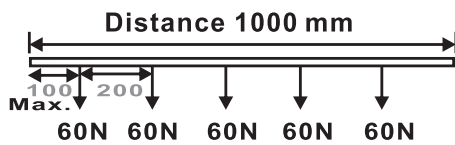

L/mm	a/mm	b/mm	c/mm	d/mm
1000	100			
2000	100	1000		
3000	100		1500	
4000	100		1333	1333

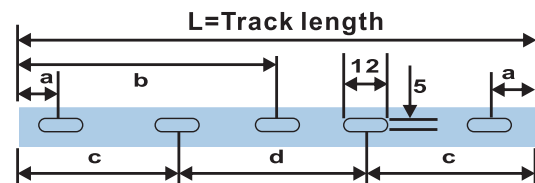
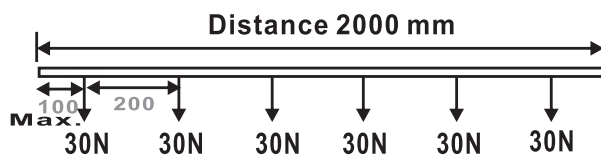

Available colours: -W(white Ral 9003), -B(black Ral 9004), -G(gray Ral 7040).

Type	Dimensions in mm/ track length	Surface Colour	PCS/ Carton
TL-04C2-1-W	1000	White	9
TL-04C2-1-B	1000	Black	9
TL-04C2-1-G	1000	Gray	9
TL-04C2-2-W	2000	White	9
TL-04C2-2-B	2000	Black	9
TL-04C2-2-G	2000	Gray	9
TL-04C2-3-W	3000	White	9
TL-04C2-3-B	3000	Black	9
TL-04C2-3-G	3000	Gray	9
TL-04C2-4-W	4000	White	9
TL-04C2-4-B	4000	Black	9
TL-04C2-4-G	4000	Gray	9

### 3 Phase Track Accessory

Power connector is to start a run in the track.



Type	Color	Pcs/Carton
TL-04C-JL-W	White	294
TL-04C-JL-B	Black	294
TL-04C-JL-G	Gray	294
TL-04C-JR-W	White	294
TL-04C-JR-B	Black	294
TL-04C-JR-G	Gray	294

Straight connector is to connect two tracks end-to-end.



TL-04C-I-W	White	160
TL-04C-I-B	Black	160
TL-04C-I-G	Gray	160

L connector is to connect two tracks to a 90° angle.

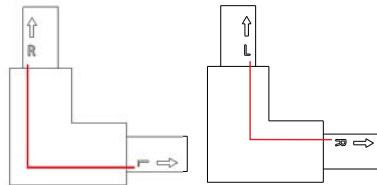

TL-04C-LL-W	White	150
TL-04C-LL-B	Black	150
TL-04C-LL-G	Gray	150
TL-04C-LR-W	White	150
TL-04C-LR-B	Black	150
TL-04C-LR-G	Gray	150

T connector is to connect three tracks to a T section.

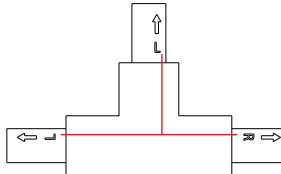
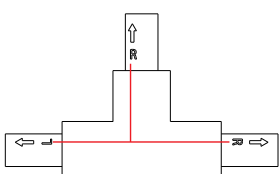
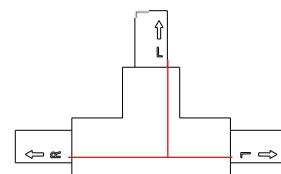
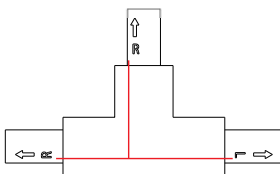

TL-04C-TL1-W	White	90
TL-04C-TL1-B	Black	90
TL-04C-TL1-G	Gray	90
TL-04C-TL2-W	White	90
TL-04C-TL2-B	Black	90
TL-04C-TL2-G	Gray	90
TL-04C-TR1-W	White	90
TL-04C-TR1-B	Black	90
TL-04C-TR1-G	Gray	90
TL-04C-TR2-W	White	90
TL-04C-TR2-B	Black	90
TL-04C-TR2-G	Gray	90

## 3 Phase Track Accessory

+ connector is to connect four tracks into a cross section.

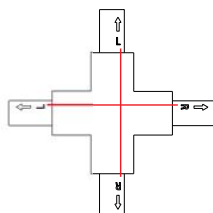

Type	Color	Pcs/Carton
TL-04C-X-W	White	60
TL-04C-X-B	Black	60
TL-04C-X-G	Gray	60

End cap put at the end to ensure safety and dust-proofing.



TL-04C-E-W	White	1000
TL-04C-E-B	Black	1000
TL-04C-E-G	Gray	1000

Mini joiner is to join two straight tracks end-to-end.



TL-04C-MI-W	White	500
TL-04C-MI-B	Black	500
TL-04C-MI-G	Gray	500

Flexible connector is to connect two tracks at any angle up to 90° or wall to ceiling or pitched ceiling applications.



TL-04C-S-W	White	80
TL-04C-S-B	Black	80
TL-04C-S-G	Gray	80

Suspension Kits are to fix the track on the ceiling or hang it in the air.



TL-SK1



TL-SK2

TL-04C-SK1-W	White	200
TL-04C-SK1-B	Black	200
TL-04C-SK1-G	Gray	200

TL-04C-SK2-W	White	200
TL-04C-SK2-B	Black	200
TL-04C-SK2-G	Gray	200



TL-SK3 (Flexible Spring Clamp)



TL-SK4

TL-04C-SK3-W	White	1000
TL-04C-SK3-B	Black	1000

TL-04C-SK4-W	White	500
TL-04C-SK4-B	Black	500

## Square 3 Phase Track Rail System



Each track adopts copper wires with plastic unibody process.

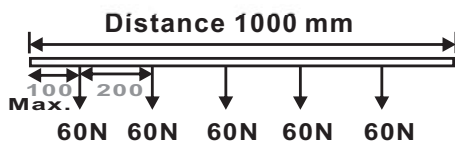
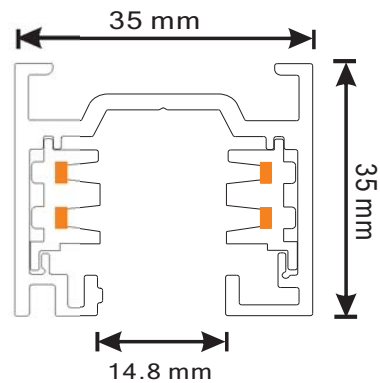

L/mm	a/mm	b/mm	c/mm	d/mm
1000	100			
2000	100	1000		
3000	100		1500	
4000	100		1333	1333

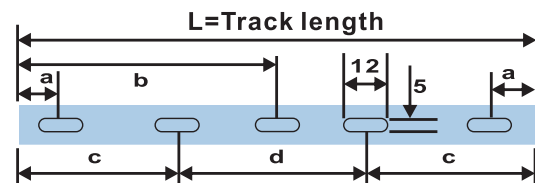
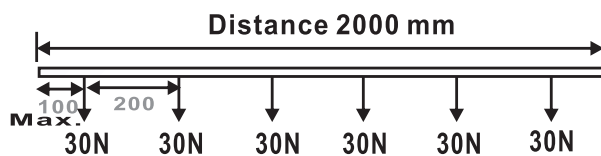

Available colours: -W(white Ral 9003), -B(black Ral 9004), -G(gray Ral 7040).

Type	Dimensions in mm/ track length	Surface Colour	PCS/ Carton
TL-04S1-1-W	1000	White	12
TL-04S1-1-B	1000	Black	12
TL-04S1-1-G	1000	Gray	12
TL-04S1-2-W	2000	White	12
TL-04S1-2-B	2000	Black	12
TL-04S1-2-G	2000	Gray	12
TL-04S1-3-W	3000	White	12
TL-04S1-3-B	3000	Black	12
TL-04S1-3-G	3000	Gray	12
TL-04S1-4-W	4000	White	12
TL-04S1-4-B	4000	Black	12
TL-04S1-4-G	4000	Gray	12

## Recessed Square 3 Phase Track System



Each track adopts copper wires with plastic unibody process.

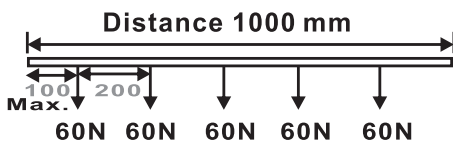
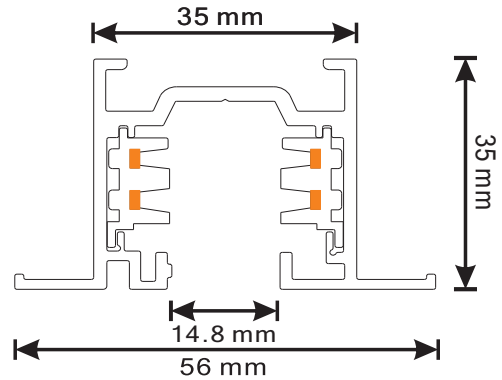

L/mm	a/mm	b/mm	c/mm	d/mm
1000	100			
2000	100	1000		
3000	100		1500	
4000	100		1333	1333

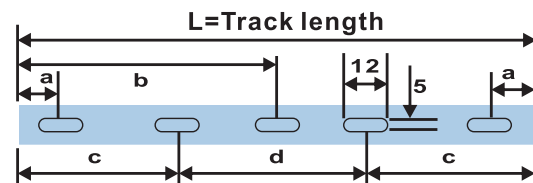
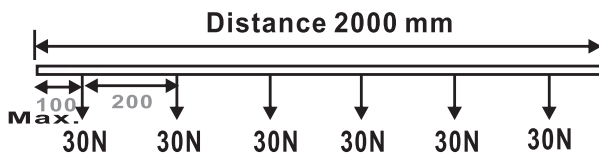

Available colours: -W(white Ral 9003), -B(black Ral 9004), -G(gray Ral 7040).

Type	Dimensions in mm/ track length	Surface Colour	PCS/ Carton
TL-04S2-1-W	1000	White	6
TL-04S2-1-B	1000	Black	6
TL-04S2-1-G	1000	Gray	6
TL-04S2-2-W	2000	White	6
TL-04S2-2-B	2000	Black	6
TL-04S2-2-G	2000	Gray	6
TL-04S2-3-W	3000	White	6
TL-04S2-3-B	3000	Black	6
TL-04S2-3-G	3000	Gray	6
TL-04S2-4-W	4000	White	6
TL-04S2-4-B	4000	Black	6
TL-04S2-4-G	4000	Gray	6



## Square 3 Phase Track Accessory

Power connector is to start a run in the track.

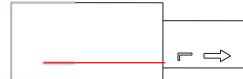

Type	Color	Pcs/Carton
TL-04S-JL-W	White	294
TL-04S-JL-B	Black	294
TL-04S-JL-G	Gray	294
TL-04S-JR-W	White	294
TL-04S-JR-B	Black	294
TL-04S-JR-G	Gray	294



Straight connector is to connect two tracks end-to-end.



TL-04S-I-W	White	160
TL-04S-I-B	Black	160
TL-04S-I-G	Gray	160

L connector is to connect two tracks to a 90° angle.

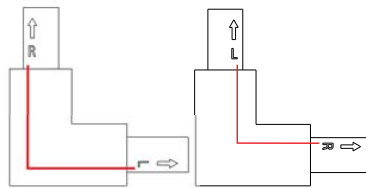

TL-04S-LL-W	White	150
TL-04S-LL-B	Black	150
TL-04S-LL-G	Gray	150

TL-04S-LR-W	White	150
TL-04S-LR-B	Black	150
TL-04S-LR-G	Gray	150

T connector is to connect three tracks into a T section.



TL-04S-TL1-W	White	90
TL-04S-TL1-B	Black	90
TL-04S-TL1-G	Gray	90

TL-04S-TL2-W	White	90
TL-04S-TL2-B	Black	90
TL-04S-TL2-G	Gray	90

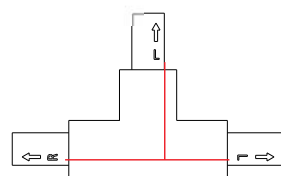
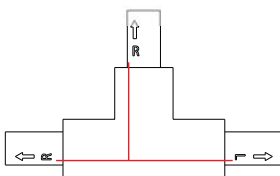

TL-04S-TR1-W	White	90
TL-04S-TR1-B	Black	90
TL-04S-TR1-G	Gray	90

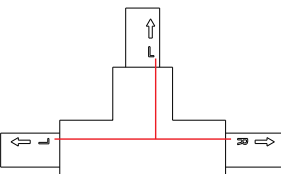
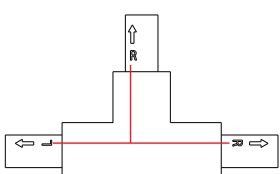

TL-04S-TR2-W	White	90
TL-04S-TR2-B	Black	90
TL-04S-TR2-G	Gray	90

## Square 3 Phase Track Accessory

+ connector is to connect four tracks to a cross section.

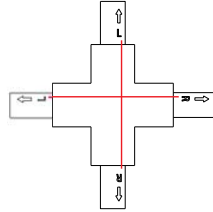

Type	Color	Pcs/Carton
------	-------	------------

TL-04S-X-W	White	60
TL-04S-X-B	Black	60
TL-04S-X-G	Gray	60

End cap put at the end to ensure safety and dust-proofing.



TL-04S-E-W	White	1000
TL-04S-E-B	Black	1000
TL-04S-E-G	Gray	1000

Mini joiner is to connect two tracks end-to-end.



TL-04S-MI-W	White	500
TL-04S-MI-B	Black	500
TL-04S-MI-G	Gray	500

Flexible connector is to connect two tracks at any angle up to 90° or pitched ceiling applications.



TL-04S-S-W	White	80
TL-04S-S-B	Black	80
TL-04S-S-G	Gray	80

Suspension Kits are to fix the track on the ceiling or hang it in the air.



TL-04S-SK1-W	White	200
TL-04S-SK1-B	Black	200
TL-04S-SK1-G	Gray	200



TL-04S-SK2-W	White	400
TL-04S-SK2-B	Black	400
TL-04S-SK2-G	Gray	400

## Single Phase 3-Wire Track Rail System



Each track adopts copper wires with plastic unibody process.

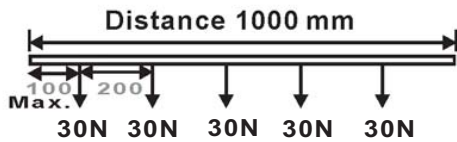
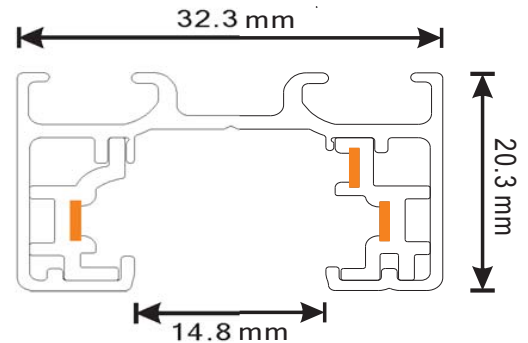

L/mm	a/mm	b/mm	c/mm	d/mm
1000	100			
2000	100	1000		
3000	100		1500	
4000	100		1333	1333

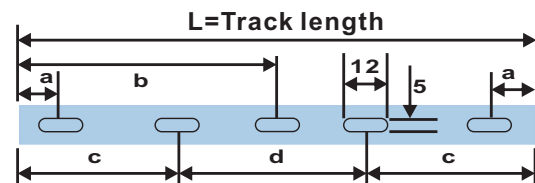
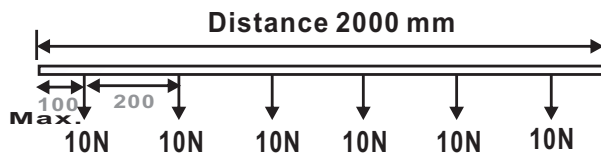

Available colours: -W(white Ral 9003), -B(black Ral 9004), -G(gray Ral 7040).

Type	Dimensions in mm/ track length	Surface Colour	PCS/ Carton
TL-03S1-1-W	1000	White	20
TL-03S1-1-B	1000	Black	20
TL-03S1-1-G	1000	Gray	20
TL-03S1-2-W	2000	White	20
TL-03S1-2-B	2000	Black	20
TL-03S1-2-G	2000	Gray	20
TL-03S1-3-W	3000	White	20
TL-03S1-3-B	3000	Black	20
TL-03S1-3-G	3000	Gray	20
TL-03S1-4-W	4000	White	20
TL-03S1-4-B	4000	Black	20
TL-03S1-4-G	4000	Gray	20

## Recessed 3-Wire Track Rail System



Each track adopts copper wires with plastic unibody process.

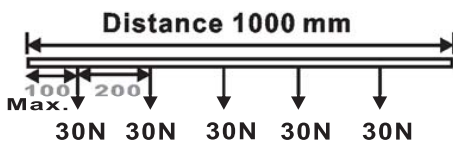
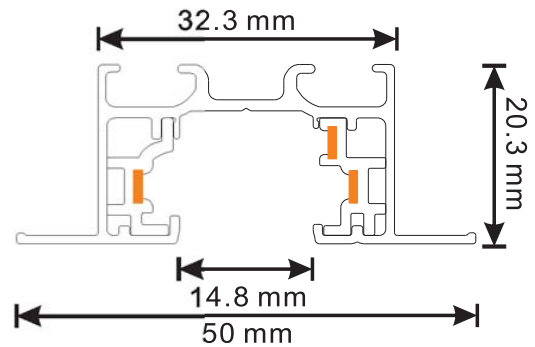

L/mm	a/mm	b/mm	c/mm	d/mm
1000	100			
2000	100	1000		
3000	100		1500	
4000	100		1333	1333

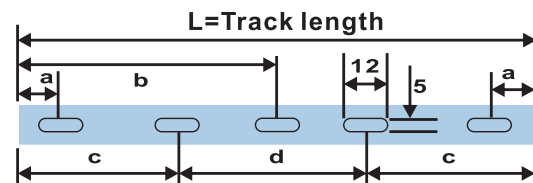
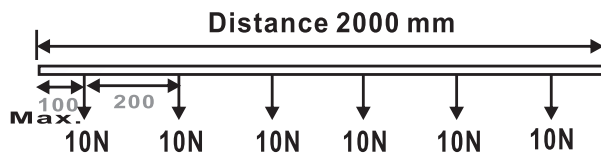

Available colours: -W(white Ral 9003), -B(black Ral 9004), -G(gray Ral 7040).

Type	Dimensions in mm/ track length	Surface Colour	PCS/ Carton
TL-03S2-1-W	1000	White	16
TL-03S2-1-B	1000	Black	16
TL-03S2-1-G	1000	Gray	16
TL-03S2-2-W	2000	White	16
TL-03S2-2-B	2000	Black	16
TL-03S2-2-G	2000	Gray	16
TL-03S2-3-W	3000	White	16
TL-03S2-3-B	3000	Black	16
TL-03S2-3-G	3000	Gray	16
TL-03S2-4-W	4000	White	16
TL-03S2-4-B	4000	Black	16
TL-03S2-4-G	4000	Gray	16

## Single 3-Wire Track Accessory

Power connector is to start a run in the track.



Type	Color	Pcs/Carton
TL-03S-JL-W	White	294
TL-03S-JL-B	Black	294
TL-03S-JL-G	Gray	294
TL-03S-JR-W	White	294
TL-03S-JR-B	Black	294
TL-03S-JR-G	Gray	294

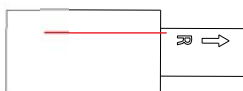

Straighter connector is to connect two tracks end-to-end.

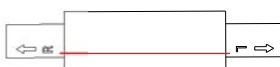

TL-03S-I-W	White	160
TL-03S-I-B	Black	160
TL-03S-I-G	Gray	160

L connector is to connect two tracks to a 90° angle.

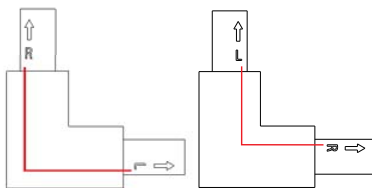
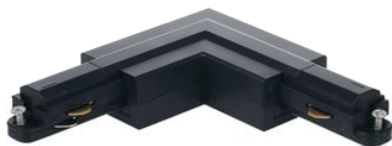

TL-03S-LL-W	White	150
TL-03S-LL-B	Black	150
TL-03S-LL-G	Gray	150

TL-03S-LR-W	White	150
TL-03S-LR-B	Black	150
TL-03S-LR-G	Gray	150

T connector is to connect three tracks to a T section.



TL-03S-TL1-W	White	90
TL-03S-TL1-B	Black	90
TL-03S-TL1-G	Gray	90

TL-03S-TL2-W	White	90
TL-03S-TL2-B	Black	90
TL-03S-TL2-G	Gray	90

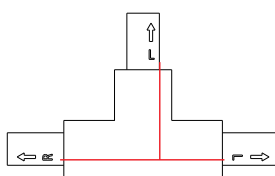
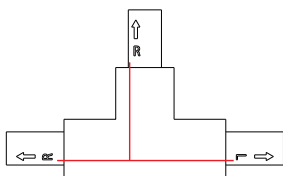

TL-03S-TR1-W	White	90
TL-03S-TR1-B	Black	90
TL-03S-TR1-G	Gray	90

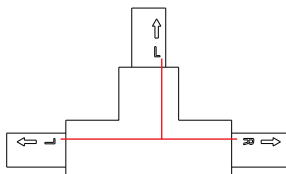
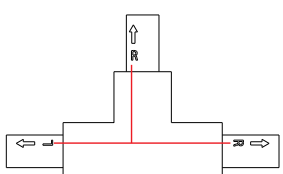

TL-03S-TR2-W	White	90
TL-03S-TR2-B	Black	90
TL-03S-TR2-G	Gray	90

## Single Phase 3-Wire Track Accessory

+ connector is to connect four tracks to a cross section.

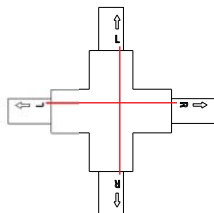

Type	Color	Pcs/Carton
------	-------	------------

TL-03S-X-W	White	60
TL-03S-X-B	Black	60
TL-03S-X-G	Gray	60

End cap is put at the end to ensure safety and dust-proofing.



TL-03S-E-W	White	1000
TL-03S-E-B	Black	1000
TL-03S-E-G	Gray	1000

Flexible connector is to connect two tracks at any angle up to 90° or pitched ceiling applications.



TL-03S-S-W	White	80
TL-03S-S-B	Black	80
TL-03S-S-G	Gray	80

Suspension Kits are to fix the track on the ceiling or hang it in the air.



TL-03S-SK1-W	White	200
TL-03S-SK1-B	Black	200
TL-03S-SK1-G	Gray	200



TL-03S-SK2-W	White	400
TL-03S-SK2-B	Black	400
TL-03S-SK2-G	Gray	400

## Single Phase 2-Wire Track Rail System

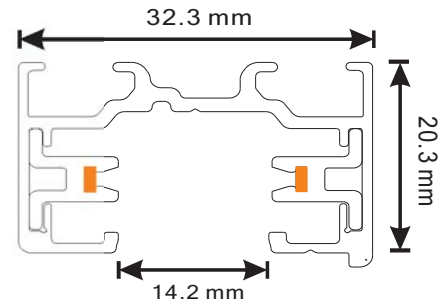

Each track adopts copper wires with plastic unibody process.

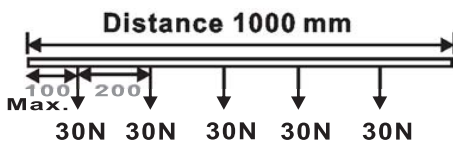

L/mm	a/mm	b/mm	c/mm	d/mm
1000	100			
2000	100	1000		
3000	100		1500	
4000	100		1333	1333

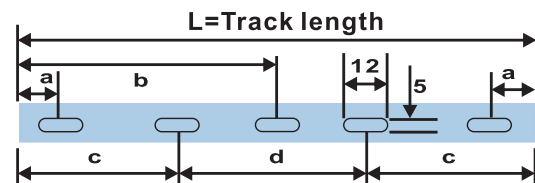
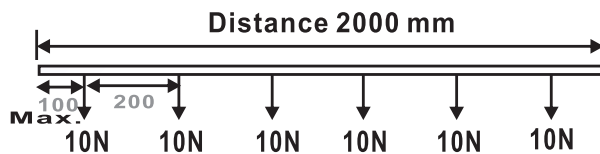

Available colours: -W(white Ral 9003), -B(black Ral 9004), -G(gray Ral 7040).

Type	Dimensions in mm/ track length	Surface Colour	PCS/ Carton
TL-02S1-1-W	1000	White	20
TL-02S1-1-B	1000	Black	20
TL-02S1-1-G	1000	Gray	20
TL-02S1-2-W	2000	White	20
TL-02S1-2-B	2000	Black	20
TL-02S1-2-G	2000	Gray	20
TL-02S1-3-W	3000	White	20
TL-02S1-3-B	3000	Black	20
TL-02S1-3-G	3000	Gray	20
TL-02S1-4-W	4000	White	20
TL-02S1-4-B	4000	Black	20
TL-02S1-4-G	4000	Gray	20

## Recessed 2-Wire Track Rail System

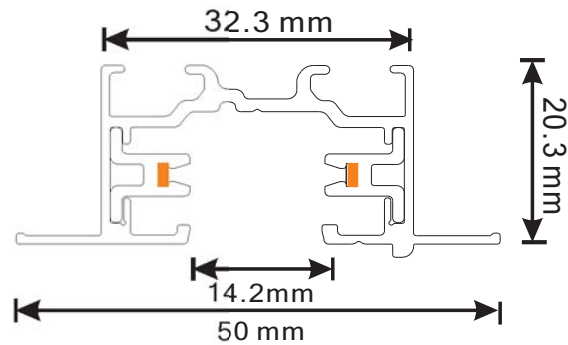

Each track adopts copper wires with plastic unibody process.

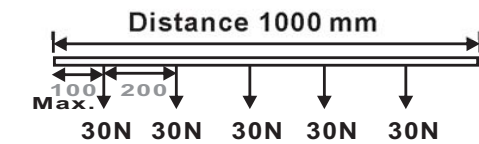

L/mm	a/mm	b/mm	c/mm	d/mm
1000	100			
2000	100	1000		
3000	100		1500	
4000	100		1333	1333

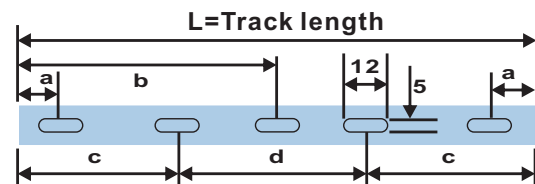
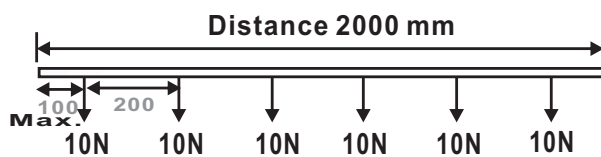

Available colours: -W(white Ral 9003), -B(black Ral 9004), -G(gray Ral 7040).

Type	Dimensions in mm/ track length	Surface Colour	PCS/ Carton
TL-02S2-1-W	1000	White	16
TL-02S2-1-B	1000	Black	16
TL-02S2-1-G	1000	Gray	16
TL-02S2-2-W	2000	White	16
TL-02S2-2-B	2000	Black	16
TL-02S2-2-G	2000	Gray	16
TL-02S2-3-W	3000	White	16
TL-02S2-3-B	3000	Black	16
TL-02S2-3-G	3000	Gray	16
TL-02S2-4-W	4000	White	16
TL-02S2-4-B	4000	Black	16
TL-02S2-4-G	4000	Gray	16



## Single Phase 2-Wire Track Accessory

Power connector is to start a run in the track.

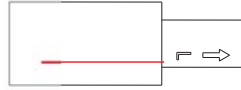

Type	Color	Pcs/Carton
TL-02S-JL-W	White	294
TL-02S-JL-B	Black	294
TL-02S-JL-G	Gray	294

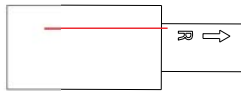

TL-02S-JR-W	White	294
TL-02S-JR-B	Black	294
TL-02S-JR-G	Gray	294

Straight connector is to connect two tracks end-to-end.

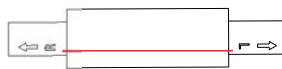

TL-02S-I-W	White	160
TL-02S-I-B	Black	160
TL-02S-I-G	Gray	160

L connector is to connect two tracks to a 90° angle.

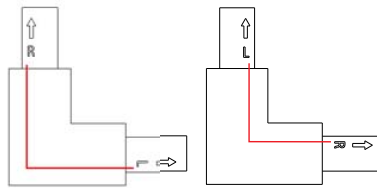

TL-02S-LL-W	White	150
TL-02S-LL-B	Black	150
TL-02S-LL-G	Gray	150

TL-02S-LR-W	White	150
TL-02S-LR-B	Black	150
TL-02S-LR-G	Gray	150

T connector is to connect three tracks to a T configuration.



TL-02S-TL1-W	White	90
TL-02S-TL1-B	Black	90
TL-02S-TL1-G	Gray	90

TL-02S-TL2-W	White	90
TL-02S-TL2-B	Black	90
TL-02S-TL2-G	Gray	90

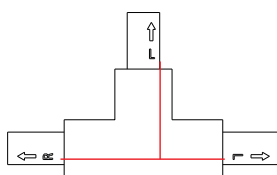
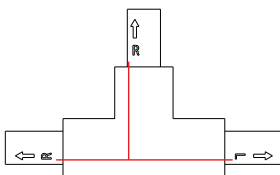

TL-02S-TR1-W	White	90
TL-02S-TR1-B	Black	90
TL-02S-TR1-G	Gray	90

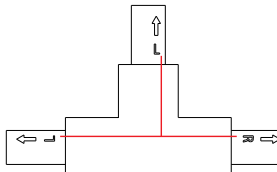
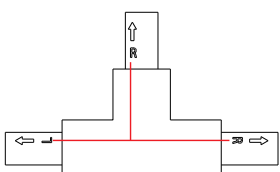

TL-02S-TR2-W	White	90
TL-02S-TR2-B	Black	90
TL-02S-TR2-G	Gray	90

## Single Phase 2-Wire Track Accessory

+ connector is to connect four tracks to a cross section. Type Color Pcs/Carton

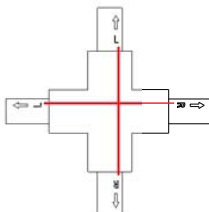

TL-02S-X-W	White	60
TL-02S-X-B	Black	60
TL-02S-X-G	Gray	60

End cap is put at the end to ensure safety and dust-proofing.



TL-02S-E-W	White	1000
TL-02S-E-B	Black	1000
TL-02S-E-G	Gray	1000

Flexible connector is to connect two tracks at any angle up to 90° or pitched ceiling applications.



TL-02S-S-W	White	80
TL-02S-S-B	Black	80
TL-02S-S-G	Gray	80

Suspension Kits are to fix the track on the ceiling or hang it in the air.



TL-02S-SK1-W	White	200
TL-02S-SK1-B	Black	200
TL-02S-SK1-G	Gray	200



TL-02S-SK2-W	White	400
TL-02S-SK2-B	Black	400
TL-02S-SK2-G	Gray	400

## Accessories

Adapter is to connect lamps or devices to the track



Type	Color	Pcs/Carton
TL-04-J-W	White	168
TL-04-J-B	Black	168
TL-04-J-G	Gray	168

Adapter is to connect lamps or devices to the track

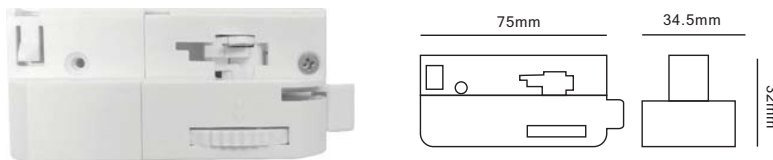

Type	Color	Pcs/Carton
TL-03-J-W	White	168
TL-03-J-B	Black	168
TL-03-J-G	Gray	168

Adapter is to connect lamps or devices to the track



Type	Color	Pcs/Carton
TL-02-J-W	White	168
TL-02-J-B	Black	168
TL-02-J-G	Gray	168

## Installation of Suspension Kits

